

 **HONDA**



ST 1300
ST 1300A

OWNER'S MANUAL



**Honda PAN EUROPEAN
ST1300/A**

OWNER'S MANUAL

IMPORTANT INFORMATION

- **OPERATOR AND PASSENGER**

This motorcycle is designed to carry the operator and one passenger. Never exceed the maximum weight capacity as shown on the accessories and loading label.

- **ON-ROAD USE**

This motorcycle is designed to be used only on the road.

- **READ THIS OWNER'S MANUAL CAREFULLY**

Pay special attention to the safety messages that appear throughout the manual. These messages are fully explained in the "A Few Words About Safety" section which appears before the Contents page.

This manual should be considered a permanent part of the motorcycle and should remain with the motorcycle when resold.

**Honda PAN EUROPEAN
ST1300/A
OWNER'S MANUAL**

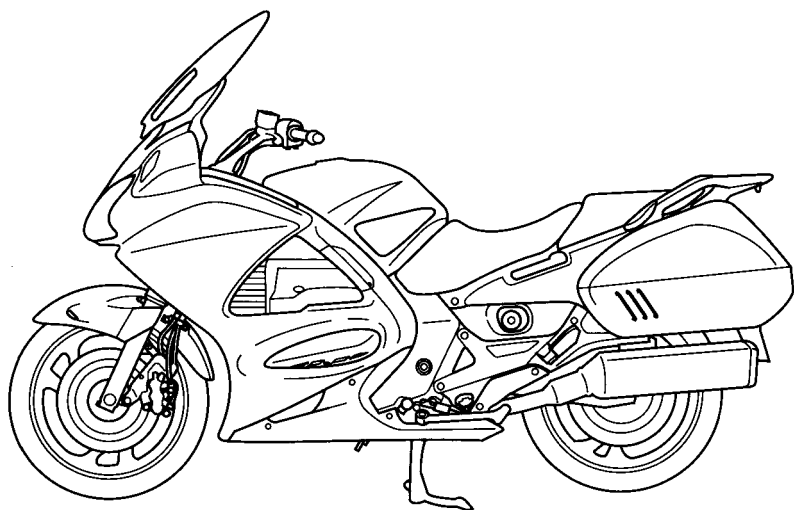

All information in this publication is based on the latest production information available at the time of approval for printing. Honda Motor Co.,Ltd. reserves the right to make changes at any time without notice and without incurring any obligation.

No part of this publication may be reproduced without written permission.

WELCOME

The motorcycle presents you a challenge to master the machine, a challenge to adventure. You ride through the wind, linked to the road by a vehicle that responds to your commands as no other does. Unlike an automobile, there is no metal cage around you. Like an airplane, a pre-ride inspection and regular maintenance are essential to your safety. Your reward is freedom.

To meet the challenges safely, and to enjoy the adventure fully, you should become thoroughly familiar with this owner's manual BEFORE YOU RIDE THE MOTORCYCLE.

As you read this manual, you will find information that is preceded by a **NOTICE** symbol. This information is intended to help you avoid damage to your motorcycle, other property, or the environment.

When service is required, remember that your Honda dealer knows your motorcycle best. If you have the required mechanical "know-how" and tools, your dealer can supply you with an official Honda Shop Manual to help you perform many maintenance and repair tasks.

Pleasant riding, and thank you for choosing a Honda !

- The following codes in this manual indicate each country.
- The illustrations herein are based on the ST1300A type.
- The illustrations herein are based on the ED type.

E	UK	Ireland	
ED	European direct sales		
	Italy	Switzerland	Norway
	Austria	Sweden	Finland
	Holland	Spain	Portugal
	Greece	Denmark	
F	France		
U	Australia	New Zealand	

- The specifications may vary with each locale.

A FEW WORDS ABOUT SAFETY

Your safety, and the safety of others, is very important. And operating this motorcycle safely is an important responsibility.

To help you make informed decisions about safety, we have provided operating procedures and other information on labels and in this manual. This information alerts you to potential hazards that could hurt you or others.

Of course, it is not practical or possible to warn you about all hazards associated with operating or maintaining a motorcycle. You must use your own good judgment.

You will find important safety information in a variety of forms, including:

- **Safety Labels** — on the motorcycle.
- **Safety Messages** — preceded by a safety alert symbol  and one of three signal words: **DANGER**, **WARNING**, or **CAUTION**.

These signal words mean:

⚠ DANGER

You **WILL** be **KILLED** or **SERIOUSLY HURT** if you don't follow instructions.

⚠ WARNING

You **CAN** be **KILLED** or **SERIOUSLY HURT** if you don't follow instructions.

⚠ CAUTION

You **CAN** be **HURT** if you don't follow instructions.

- **Safety Headings** — such as Important Safety Reminders or Important Safety Precautions.
- **Safety Section** — such as Motorcycle Safety.
- **Instructions** — how to use this motorcycle correctly and safely.

This entire manual is filled with important safety information — please read it carefully.

CONTENTS

OPERATION

Page

- 1 MOTORCYCLE SAFETY**
 - 1 IMPORTANT SAFETY INFORMATION
 - 2 PROTECTIVE APPAREL
 - 4 LOAD LIMITS AND GUIDELINES
 - 8 SAFETY LABELS

- 11 PARTS LOCATION**
 - 14 INSTRUMENTS AND INDICATORS
 - 18 MULTI-DISPLAY

- 28 MAJOR COMPONENTS**
(Information you need to operate this motorcycle)
 - 28 REAR SUSPENSION
 - 30 BRAKES
 - 33 CLUTCH
 - 34 COOLANT
 - 36 FUEL
 - 39 ENGINE OIL
 - 40 FINAL DRIVE OIL
 - 41 TUBELESS TYRES

- 46 ESSENTIAL INDIVIDUAL COMPONENTS**
 - 46 IGNITION SWITCH
 - 47 KEYS
 - 48 IMMOBILIZER SYSTEM (HISS)
 - 50 RIGHT HANDLEBAR CONTROLS
 - 51 LEFT HANDLEBAR CONTROLS
 - 52 WINDSCREEN HEIGHT ADJUSTMENT SWITCH
 - 53 HAZARD WARNING SYSTEM SWITCH

Page

54 FEATURES

(Not required for operation)

- 54 STEERING LOCK
- 55 SEAT
- 57 HELMET HOLDERS
- 58 SADDLEBAGS
- 60 FAIRING POCKETS
- 61 WINDSCREEN HEIGHT ADJUSTMENT
- 62 DOCUMENTS
- 63 STORAGE COMPARTMENT FOR U-SHAPED ANTI-THEFT LOCK
- 64 REARVIEW MIRRORS
- 65 HEADLIGHT AIM VERTICAL ADJUSTMENT
- 66 CLIP
- 67 FUEL TANK MAINTENANCE POSITION

69 OPERATION

- 69 PRE-RIDE INSPECTION
- 70 STARTING THE ENGINE
- 72 RUNNING-IN
- 73 RIDING
- 74 BRAKING
- 77 PARKING
- 78 ANTI-THEFT TIPS

CONTENTS

MAINTENANCE

Page

79 MAINTENANCE

- 79 THE IMPORTANCE OF MAINTENANCE
- 80 MAINTENANCE SAFETY
- 81 SAFETY PRECAUTIONS
- 82 MAINTENANCE SCHEDULE
- 84 TOOL KIT
- 85 SERIAL NUMBERS
- 86 COLOUR LABEL
- 87 COVER REMOVAL
- 91 AIR CLEANER
- 92 ENGINE OIL
- 97 SPARK PLUGS
- 99 THROTTLE OPERATION
- 100 IDLE SPEED
- 101 COOLANT
- 102 FINAL DRIVE OIL
- 103 FRONT AND REAR SUSPENSION INSPECTION
- 104 SIDE STAND
- 105 WHEEL REMOVAL
- 112 BRAKE PAD WEAR
- 113 BRAKE SYSTEM INSPECTION
- 114 BATTERY
- 116 FUSE REPLACEMENT
- 118 BULB REPLACEMENT

122 CLEANING

126 STORAGE GUIDE

- 126 STORAGE
- 127 REMOVAL FROM STORAGE

128 SPECIFICATIONS

130 CATALYTIC CONVERTERS

MOTORCYCLE SAFETY

IMPORTANT SAFETY INFORMATION

Your motorcycle can provide many years of service and pleasure — if you take responsibility for your own safety and understand the challenges that you can meet on the road.

There is much that you can do to protect yourself when you ride. You'll find many helpful recommendations throughout this manual. Following are a few that we consider most important.

Always Wear a Helmet

It's a proven fact: helmets significantly reduce the number and severity of head injuries. So always wear an approved motorcycle helmet and make sure your passenger does the same. We also recommend that you wear eye protection, sturdy boots, gloves, and other protective gear (page 3).

Make Yourself Easy to See

Some drivers do not see motorcycles because they are not looking for them. To make yourself more visible, wear bright reflective clothing, position yourself so other drivers can see you, signal before turning or changing lanes, and use your horn when it will help others notice you.

Ride Within Your Limits

Pushing the limits is another major cause of motorcycle accidents. Never ride beyond your personal abilities or faster than conditions warrant. Remember that alcohol, drugs, fatigue and inattention can significantly reduce your ability to make good judgements and ride safely.

Don't Drink and Ride

Alcohol and riding don't mix. Even one drink can reduce your ability to respond to changing conditions, and your reaction time gets worse with every additional drink. So don't drink and ride, and don't let your friends drink and ride either.

Keep Your Bike in Safe Condition

For safe riding, it's important to inspect your motorcycle before every ride and perform all recommended maintenance. Never exceed load limits, and only use accessories that have been approved by Honda for this motorcycle. See page 5 for more details.

MOTORCYCLE SAFETY

PROTECTIVE APPAREL

For your safety, we strongly recommend that you always wear an approved motorcycle helmet, eye protection, boots, gloves, long pants, and a long-sleeved shirt or jacket whenever you ride. Although complete protection is not possible, wearing proper gear can reduce the chance of injury when you ride.

Following are suggestions to help you choose proper gear.

⚠ WARNING

Not wearing a helmet increases the chance of serious injury or death in a crash.

Be sure you and your passenger always wear a helmet, eye protection and other protective apparel when you ride.

Helmets and Eye Protection

Your helmet is your most important piece of riding gear because it offers the best protection against head injuries. A helmet should fit your head comfortably and securely. A bright-coloured helmet can make you more noticeable in traffic, as can reflective strips.

An open-face helmet offers some protection, but a full-face helmet offers more. Always wear a face shield or goggles to protect your eyes and help your vision.

Additional Riding Gear

In addition to a helmet and eye protection, we also recommend:

- Sturdy boots with non-slip soles to help protect your feet and ankles.
- Leather gloves to keep your hands warm and help prevent blisters, cuts, burns and bruises.
- A motorcycle riding suit or jacket for comfort as well as protection. Bright-coloured and reflective clothing can help make you more noticeable in traffic. Be sure to avoid loose clothes that could get caught on any part of your motorcycle.

MOTORCYCLE SAFETY

LOAD LIMITS AND GUIDELINES

Your motorcycle has been designed to carry you, one passenger, cargo and accessories. When you add cargo or carry a passenger, you may feel some difference during acceleration and braking. But so long as you keep your motorcycle well-maintained, with good tyres and brakes, you can safely carry loads within the limits and guidelines given below.

However, exceeding the weight limit or carrying an unbalanced load can seriously affect your motorcycle's handling, braking and stability. Non-Honda accessories, improper modifications, and poor maintenance can also reduce your safety margin.

The following pages give more specific information on loading, accessories and modifications.

Loading

How much weight you put on your motorcycle, and how you load it, are important to your safety. Anytime you ride with a passenger or cargo you should be aware of the following information.

WARNING

Overloading or improper loading can cause a crash and you can be seriously hurt or killed.

Follow all load limits and other loading guidelines in this manual.

Load Limits

Following are the load limits for your motorcycle:

Maximum weight capacity: = 196 kg (432 lbs)

Includes the weight of the rider,
passenger, all cargo and all accessories

Putting too much weight in individual storage compartments can also affect stability and handling. So be sure to stay within the limits given below:

Maximum cargo weight: = 31 kg (68 lbs)

includes following maximum
compartment weights:

rear carrier = 9.0 kg (20.0 lbs)

each saddlebag = 9.0 kg (20.0 lbs)

each fairing pocket = 2.0 kg (4.5 lbs)

The weight of added accessories will reduce the maximum cargo weight you can carry.

Loading Guidelines

Improperly loading your motorcycle can affect its stability and handling. Even if your motorcycle is properly loaded, you should ride at reduced speeds and never exceed 130 km/h (80 mph) when carrying cargo.

Follow these guidelines whenever you carry a passenger or cargo:

- Check that both tyres are properly inflated (page 41).
- If you change your normal load, you may need to adjust your rear suspension settings (page 28) and your headlight (page 65).
- To prevent loose items from creating a hazard, make sure that storage lids are properly closed and that any other cargo is securely tied down before you ride away.

MOTORCYCLE SAFETY

- Cargo weight should be carried as low and as close to the centre of a motorcycle as possible. When loading your motorcycle, try to pack heavier items in the saddlebags and put lighter, bulkier items in the travel trunk. If you must carry heavy items in the trunk, put them as far forward as you can.
- Balance cargo weight evenly on both sides. When loading the saddlebags, for example, be sure the weight in each bag is about the same.

Accessories and Modifications

Modifying your motorcycle or using non-Honda accessories can make your motorcycle unsafe. Before you consider making any modifications or adding an accessory, be sure to read the following information.

WARNING

Improper accessories or modifications can cause a crash in which you can be seriously hurt or killed.

Follow all instructions in this owner's manual regarding accessories and modifications.

Accessories

We strongly recommend that you use only Honda Genuine Accessories that have been specifically designed and tested for your motorcycle. Because Honda cannot test all other accessories, you must be personally responsible for proper selection, installation and use of non-Honda accessories. Check with your dealer for assistance and always follow these guidelines:

- Make sure the accessory does not obscure any lights, reduce ground clearance and banking angle, limit suspension travel or steering travel, alter your riding position or interfere with operating any controls.

-
- Be sure electrical equipment does not exceed the motorcycle's electrical system capacity (page 129). A blown fuse can cause a loss of lights or engine power.
 - Do not pull a trailer or sidecar with your motorcycle. This motorcycle was not designed for these attachments, and their use can seriously impair your motorcycle's handling.

Modifications

We strongly advise you not to remove any original equipment or modify your motorcycle in any way that would change its design or operation. Such changes could seriously impair your motorcycle's handling, stability and braking, making it unsafe to ride.

Removing or modifying your lights, mufflers, emission control system or other equipment can also make your motorcycle illegal.

MOTORCYCLE SAFETY

SAFETY LABELS

The following pages show the locations of safety labels on your motorcycle. Some labels warn you of potential hazards that could cause serious injury. Others provide important safety information. Read these labels carefully and don't remove them.

If a label comes off or becomes hard to read, contact your Honda dealer for a replacement.

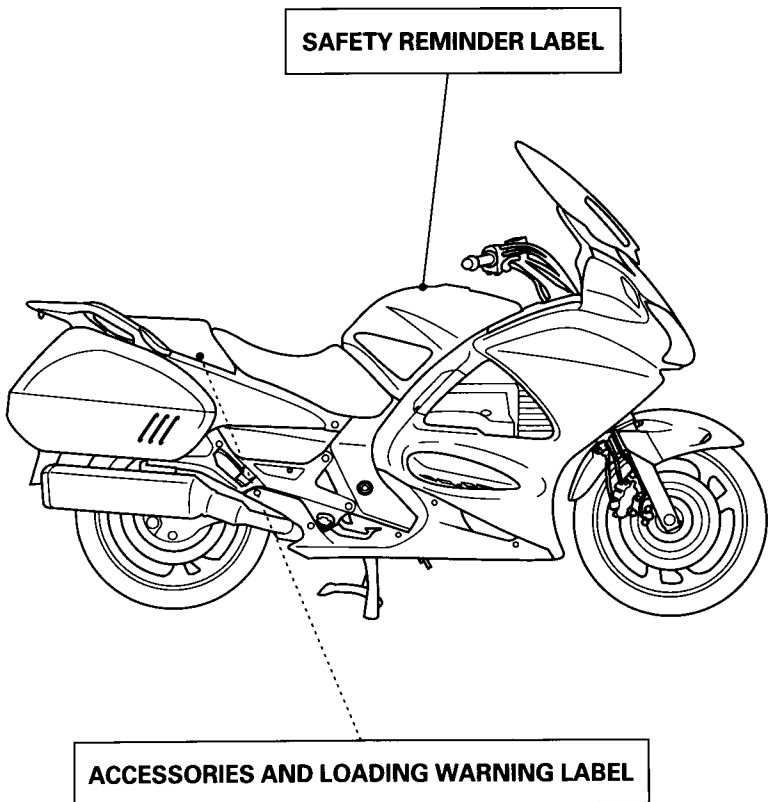

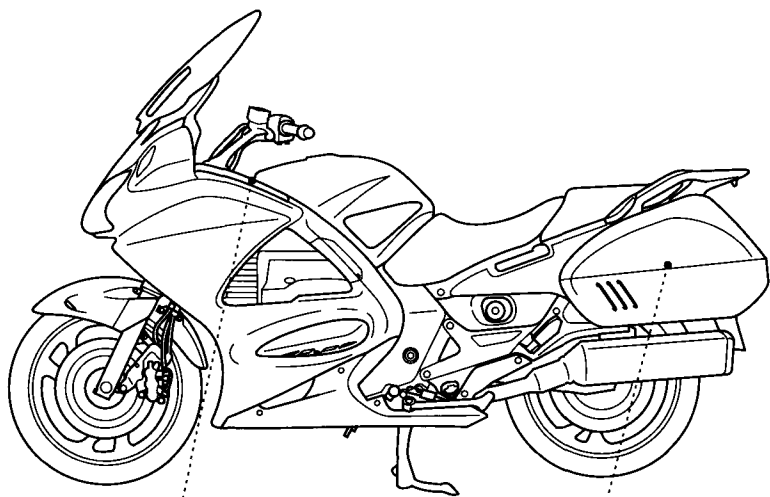

CARGO LIMIT

2.0kg / 4.5lbs

CARGO LIMIT

9.0kg / 20.0lbs

MOTORCYCLE SAFETY

CARGO LIMIT
9.0kg / 20.0lbs

TIRE INFORMATION LABEL

CARGO LIMIT
2.0kg / 4.5lbs

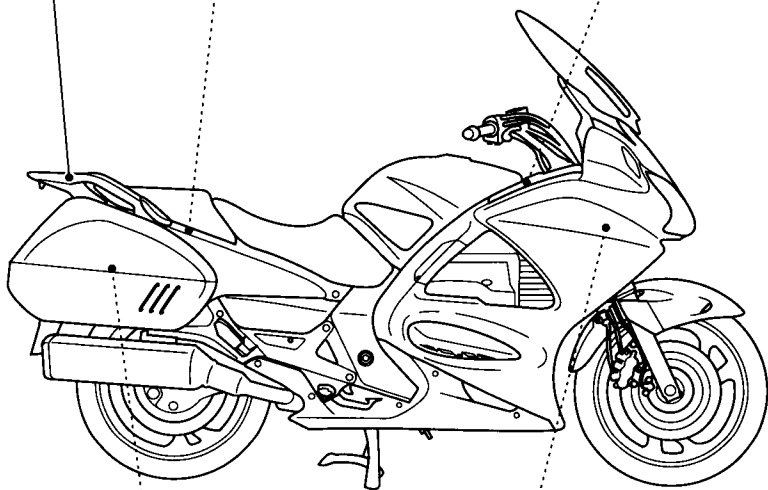

CARGO LIMIT
9.0kg / 20.0lbs

RADIATOR CAP SEAL

PARTS LOCATION

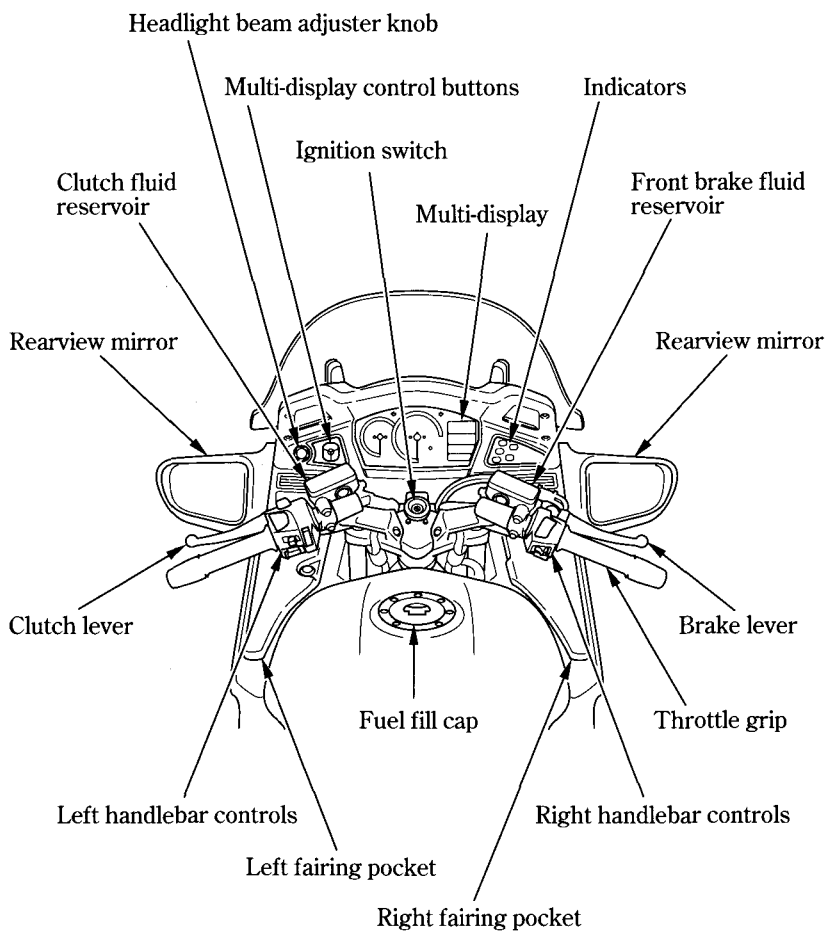

PARTS LOCATION

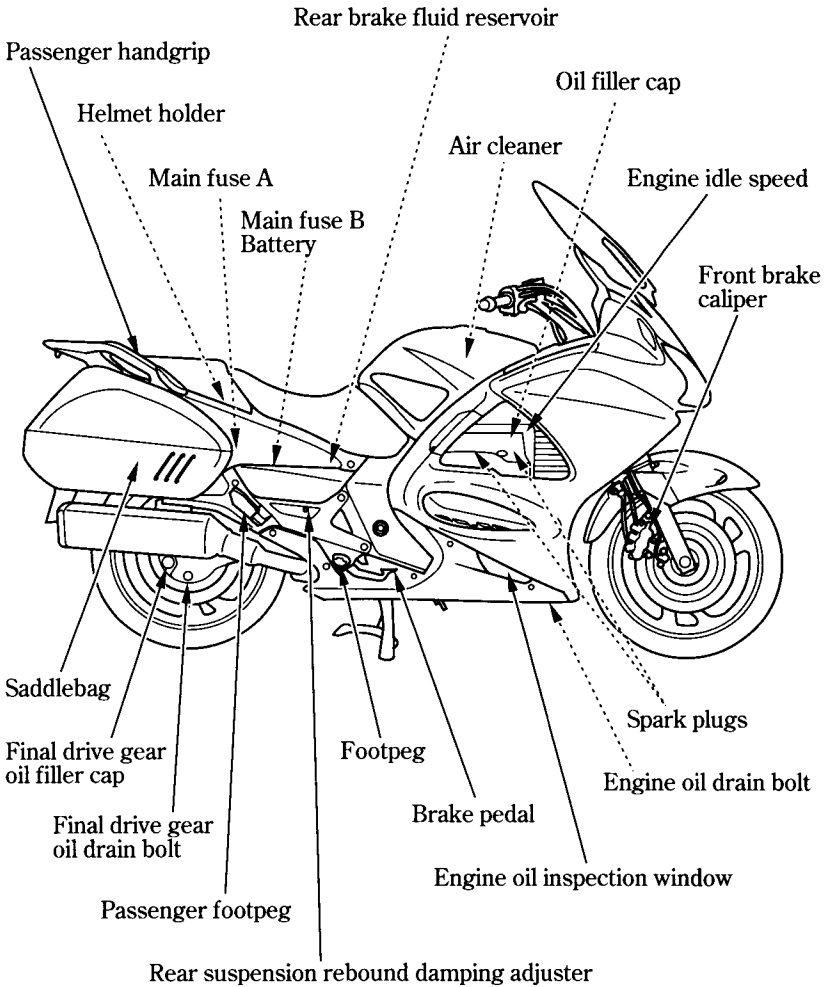

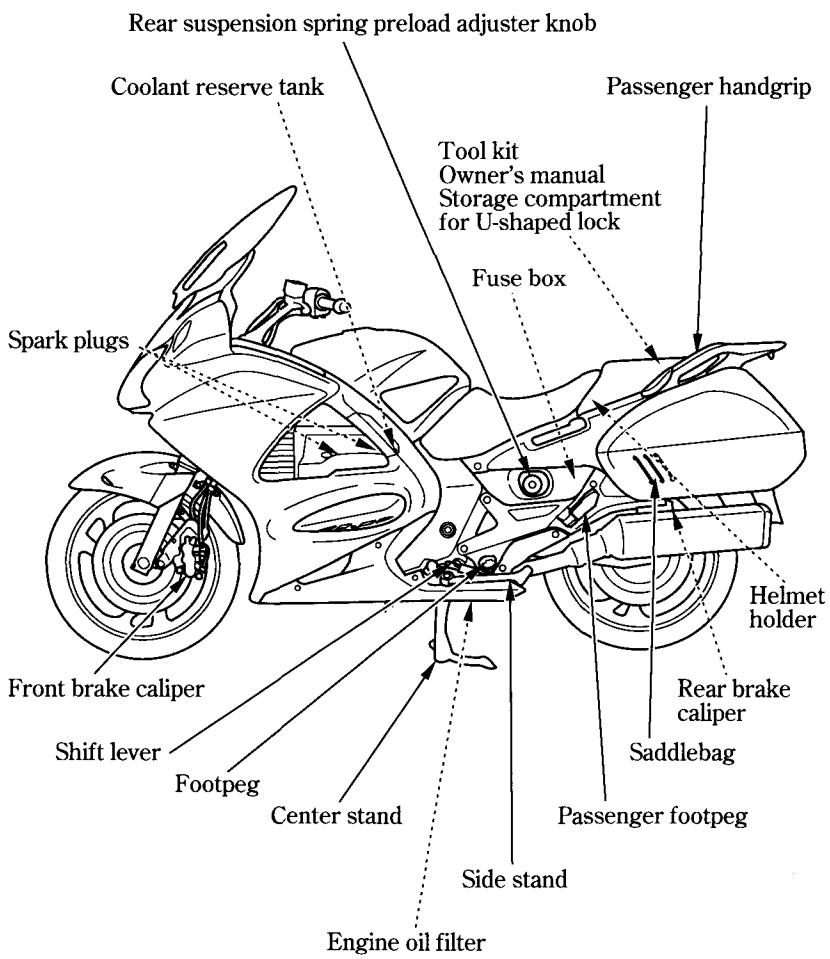

PARTS LOCATION

INSTRUMENTS AND INDICATORS

The indicators are contained in the instrument panel. Their functions are described in the tables on the following pages.

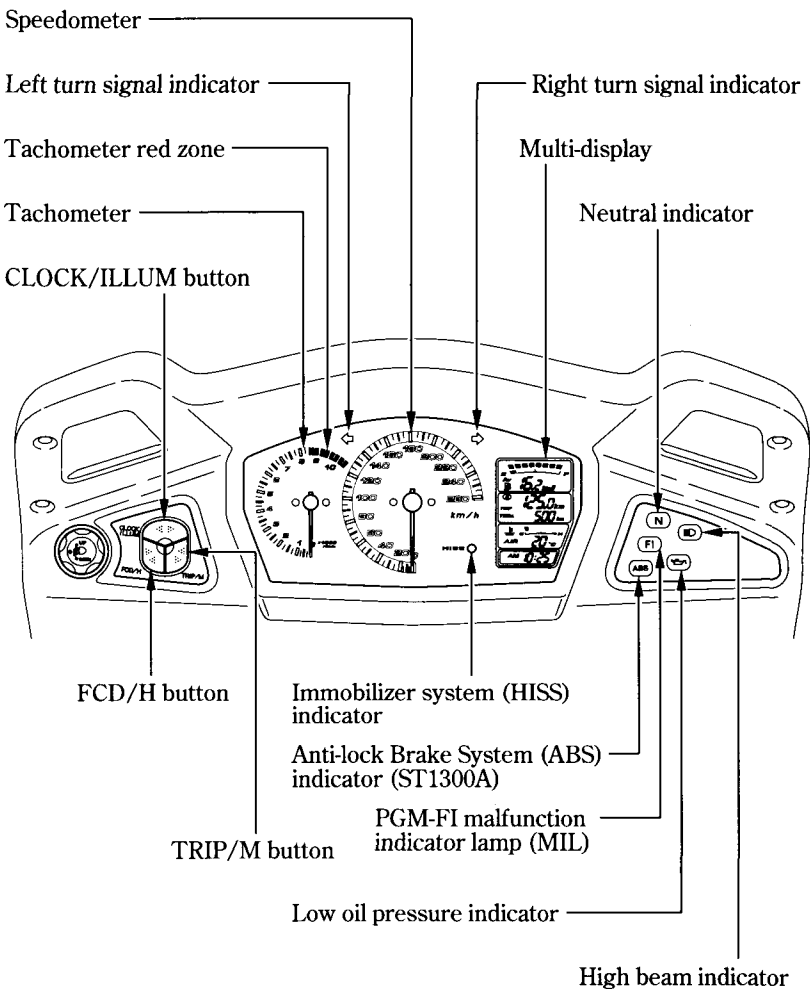



Speedometer

Shows riding speed.

This shows your speed in kilometers per hour (km/h) and/or miles per hour (mph) depending on the type.



Tachometer

Shows engine speed in revolutions per minute.



Tachometer red zone

Never allow the tachometer needle to enter the red zone, even after the engine has been broken in.

NOTICE

Running the engine beyond recommended maximum engine speed (the beginning of the tachometer red zone) can damage the engine.



Turn signal indicators (green)

Flashes when a turn signal operates.



Neutral indicator (green)

Lights when the transmission is in neutral.

PARTS LOCATION



Low oil pressure indicator (red)

Lights when the engine oil pressure is below normal operating range. Should light when ignition switch is ON and engine is not running. Should go out when the engine starts, except for occasional flickering at or near idling speed when engine is warm.

NOTICE

Running the engine with insufficient oil pressure may cause serious engine damage.



PGM-FI malfunction indicator lamp (MIL) (red)

Lights when there is any abnormality in the PGM-FI (Programmed Fuel Injection) system. Should also light for a few seconds and then go off when the ignition switch is turned ON and engine stop switch is at \odot (RUN). If the indicator comes on at any other time, reduce speed and take the motorcycle to a Honda dealer as soon as possible.



Anti-lock Brake System
(ABS) indicator
(red)
(ST1300A)

This light normally comes on when the ignition is turned ON, and goes off after you ride the motorcycle at speed above 10 km/h (6 mph). If there is a problem with the Anti-lock Brake System, this light flashes and remains on (page 76).



High beam indicator (blue)

Lights when the headlight is on high beam.



Immobilizer system
(HISS) indicator
(red)

This indicator lights for a few seconds when the ignition switch is turned ON and the engine stop switch is at  (RUN). It will then go off if the properly-coded key has been inserted. If an improperly-coded key has been inserted, the indicator will remain on and the engine will not start (page 48).

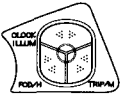

CLOCK/ILLUM button

Use this button for the following purposes.

- To adjust time
- To adjust display illumination
- To switch blinking of the immobilizer system (HISS) indicator

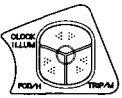

FCD/H button

Use this button for the following purposes.

- To adjust time
- To select and reset the fuel mileage meter
- To change the mileage units for the odometer/tripmeter and fuel consumption meter

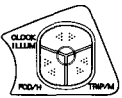

TRIP/M button

Use this button for the following purposes.

- To adjust time
- To select and reset the tripmeter

PARTS LOCATION

MULTI-DISPLAY

Your motorcycle is equipped with a Multi-display that presents various displays. This section explains display functions and operations.

Initial Display

When the ignition switch is turned ON, the display will temporarily show all the modes and digital segments so you can make sure the liquid crystal display is functioning properly. (Except digital clock)

The unit "mile/ℓ" and "mile" will be displayed only for E type.

Digital clock and tripmeter will reset if the battery is disconnected.

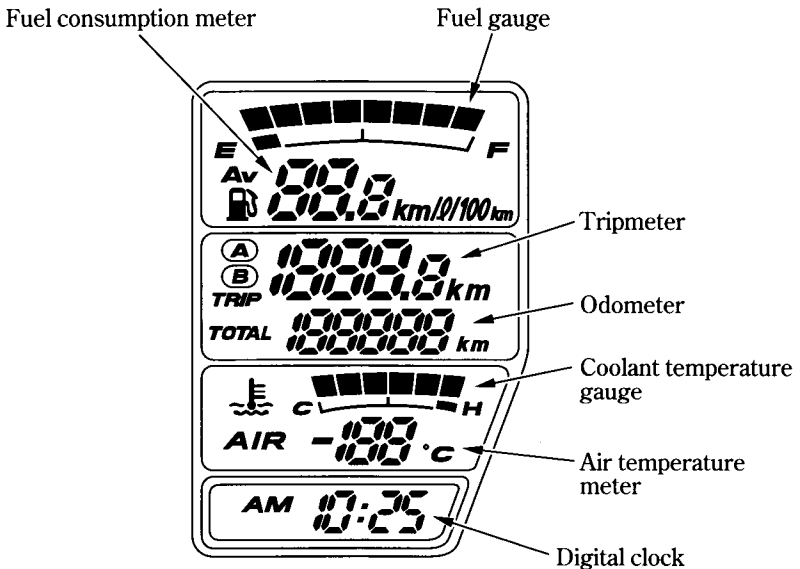

Fuel Gauge

The fuel gauge liquid crystal display shows the approximate fuel supply available in a graduated display. When the segment F goes on, the fuel tank capacity including reserve is:

29.0 l (7.66 US gal , 6.38 Imp gal)

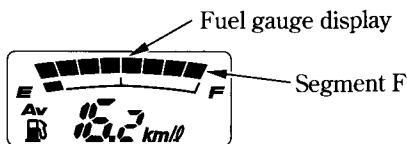

When segment E flashes, fuel will be low and you should refill the tank as soon as possible. The amount of fuel left in the tank with the vehicle set upright is approximately:

5.0 l (1.32 US gal , 1.10 Imp gal)

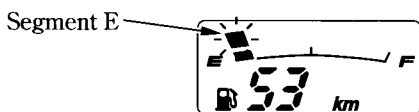

Coolant Temperature Gauge

When the segment begins to move above the C (Cold) mark, the engine is warm enough for the motorcycle to be ridden. The normal operating temperature range is within the section between the H and C marks.

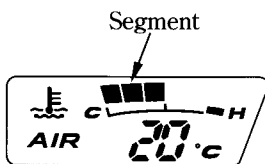

If the segment H flashes, stop the engine and check the reserve tank coolant level. Read pages 34 – 35 and do not ride the motorcycle until the problem has been corrected.

NOTICE

Exceeding maximum running temperature may cause serious engine damage.

PARTS LOCATION

Air Temperature Meter

Air temperature meter shows air temperature digitally.

Temperature Display

Below -11°C	"— —" is displayed.
Between: -10°C — 50°C	Actual air temperature is indicated.
Above 50°C	The display will remain and blink " 50°C ".

The temperature sensor is located in the fairing. The temperature reading can be affected by heat reflecting from the road surface, engine heat, and the exhaust from surrounding traffic. This can cause an error in the temperature reading when your speed is under 30 km/h (19 mph).



Fuel Consumption Meter

The fuel consumption meter allows indication of the available driving distance, the amount of remaining fuel, the current fuel consumption and the average fuel consumption. Briefly pressing the FCD/H button changes the indication as described below. The available driving distance and the amount of remaining fuel are indicated when the fuel in the fuel tank becomes 5 liters or less.

《When more than 5 liters》

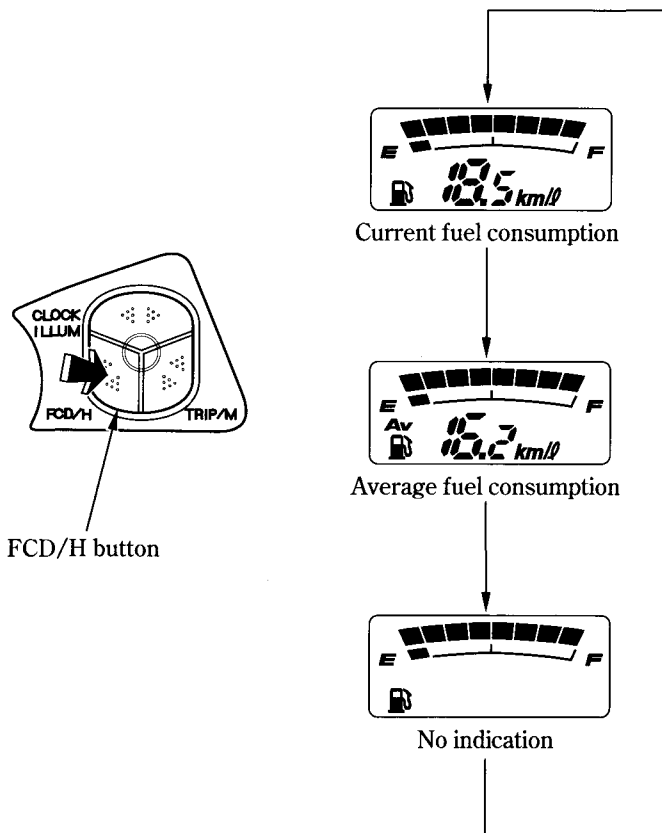

PARTS LOCATION

《When less than 5 liters》

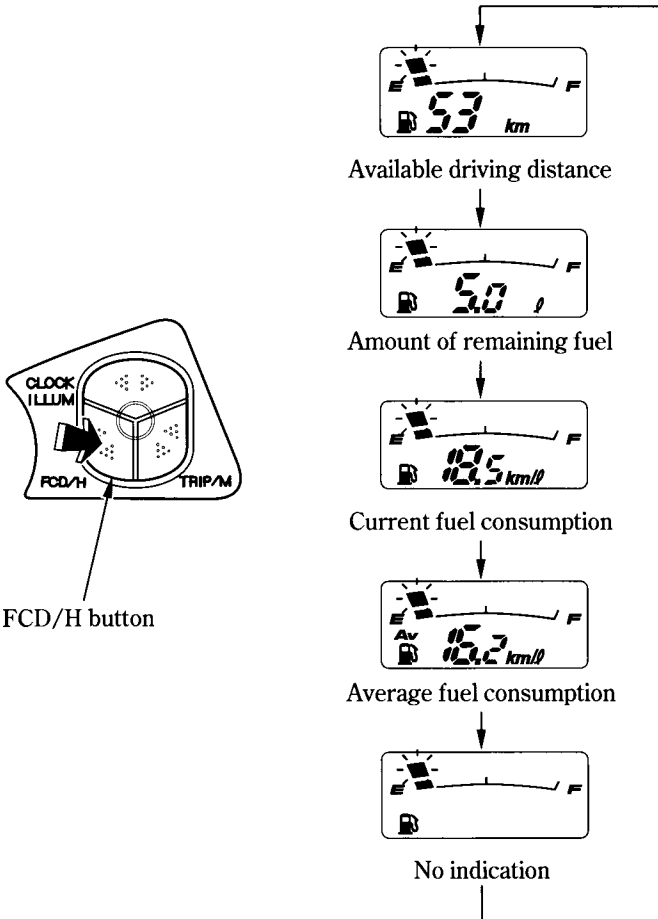

- When the remaining fuel becomes 5 liters or less, the indication automatically changes to the available driving distance.
(Except no indication)
- When the battery terminal is disconnected, the available driving distance, the amount of remaining fuel and the average fuel consumption memories will be reset.
- When the battery terminal is disconnected with 5 liters or less fuel remaining, the available driving distance and the amount of remaining fuel may be shown inaccurately in some cases.

Current Fuel Consumption

Indicates the momentary fuel consumption of each 15 seconds during engine operation. With motorcycle speed 5 km/h or below “- -” is displayed.

The indicated fuel consumption may differ from the actual fuel consumption.

The E type uses mile/ℓ or km/ℓ, the ED, F and U type in km/ℓ or ℓ/100 km.

When “- -” blinks, go to your Honda dealer.

Current fuel consumption



Average Fuel Consumption

The average fuel consumption after reset until that moment is indicated every 15 seconds.

The indicated fuel consumption may differ from the actual fuel consumption.

The E type uses mile/ℓ or km/ℓ, the ED, F and U type in km/ℓ or ℓ/100 km.

When “- -” blinks, go to your Honda dealer.

Average fuel consumption



To reset average fuel consumption:

Press and hold the FCD/H button for more than 2 seconds with the display in the average fuel consumption.

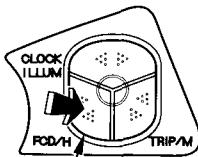

FCD/H button

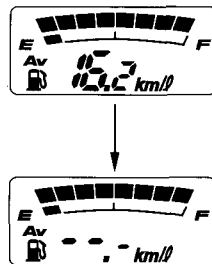

PARTS LOCATION

Available Driving Distance

When the amount of remaining fuel becomes less than 5 liters, the estimated allowable distance is indicated.

The E type uses mile or km, and others use km.

When the amount of remaining fuel becomes less than 2 liters, “-.” will be indicated.

The indicated available driving distance is by calculation depending on the driving conditions, and the indicated figure may not always be the actual allowable distance. When the fuel gauge near to E or when E segment blinks, fill fuel promptly.



Remaining Fuel

When the amount of remaining fuel becomes less than 5 liters, the estimated amount of remaining fuel is indicated.

When the amount of remaining fuel becomes less than 2 liters, “-.” will be indicated.

The amount of remaining fuel is calculated from the driving conditions.

The indicated amount of remaining fuel may be different from the actual amount. When the fuel gauge near to E or when E segment blinks, fill fuel promptly.

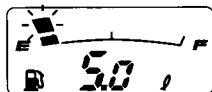

Odometer/Tripmeter

- ODO (Odometer) — shows the total miles (For E type) or kilometer (Except E type) ridden.
- TRIP (Tripmeter) — shows the number of miles (For E type) or kilometer (Except E type) ridden.

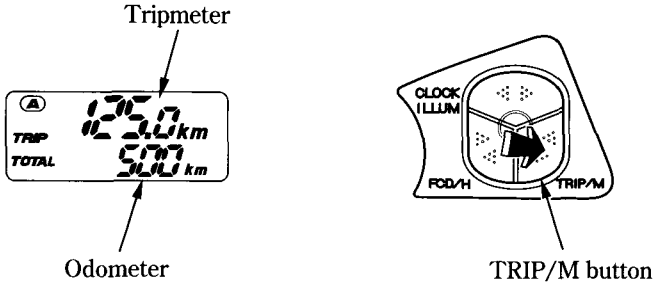

The tripmeter will show mileage in two sub modes, “tripmeter A” and “tripmeter B.”

Press the TRIP/M button to select the “tripmeter A” or “tripmeter B” mode.

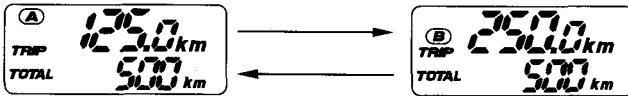

To reset the tripmeter, press and hold the TRIP/M button for more than 2 seconds with the display in the “tripmeter A” or “tripmeter B” mode.

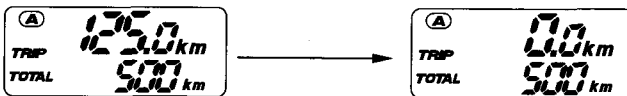

PARTS LOCATION

Digital Clock

The display shows the hour and minute.

To adjust the time:

1. Turn the ignition switch to ON or ACC.
2. Press and hold the CLOCK/ILLUM button for more than 2 seconds. The clock will be set in the adjust mode with the display flashing.
3. To set the hour, press and release the FCD/H button until the desired hour appears.
 - Quick setting — press and hold the FCD/H button until the desired hour appears.
4. To set the minute, press and release the TRIP/M button until the desired minute appears.
 - Quick setting — press and hold the TRIP/M button until the desired minute appears.
5. To end the adjustment, press the CLOCK/ILLUM button after the last adjustment, or turn the ignition switch OFF.

Wait approximately 5 seconds; the display will stop flashing automatically. If the ignition switch is turned off during the time adjustment mode, the blinking function of the immobilizer system (HISS) indicator will be altered.

After turning ignition switch OFF, the clock will display for 10 days.

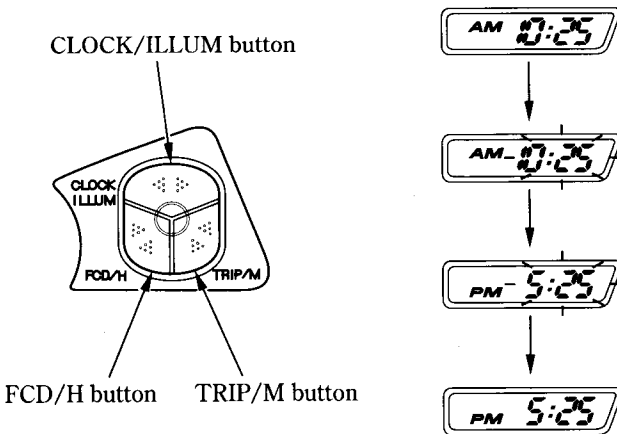

Mileage and Fuel Consumption Unit Change

The odometer/tripmeter displays either “km” or “mile”. (E type only)

The current/average fuel consumption meter displays either “km/ℓ” or “mile/ℓ” (E type)/“km/ℓ” or “ℓ/100 km” (ED, F and U type).

Press the FCD/H button to get the fuel consumption meter display shown below.

Press and hold the FCD/H button for more than 2 seconds to select.

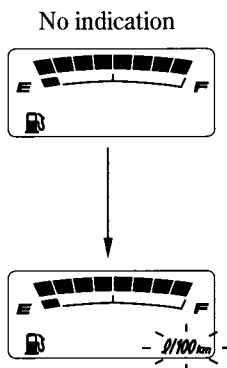
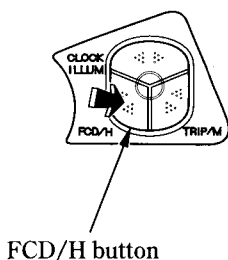

Display Illumination Adjustment

The brightness of a display can be adjusted in three stages.

To adjust the brightness of the display, press the CLOCK/ILLUM button.

CLOCK/ILLUM button

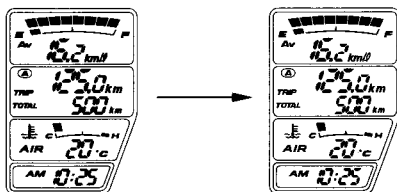
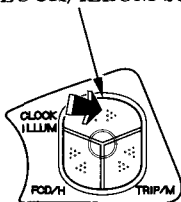

MAJOR COMPONENTS

(Information you need to operate this motorcycle)

REAR SUSPENSION

Rebound Damping:

To reduce (SOFT) :

Turn the adjuster counterclockwise toward SOFT for a light load and smooth road condition.

To increase (HARD) :

Turn the adjuster clockwise toward HARD for a firmer ride and rough road condition.

To adjust the adjuster to the standard position, proceed as follows :

1. Turn the damping adjuster clockwise until it will no longer turn (lightly seats). This is the full hard setting.
2. The adjuster is set in the standard position when the adjuster is turned counterclockwise approximately 1 turn so that its punch mark aligns with the reference punch mark.

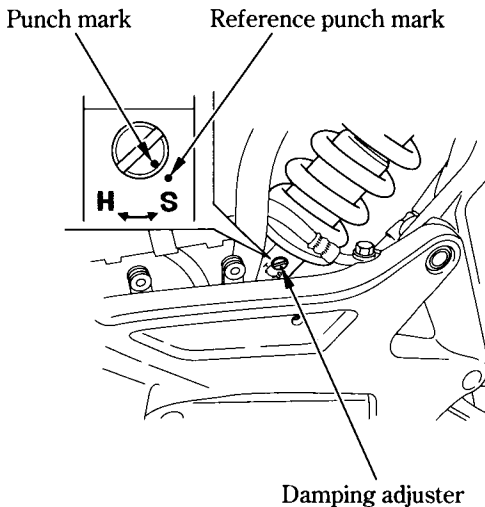

Spring Preload:

The spring preload adjuster knob has 35 spring preload positions (clicks) or more for different load or riding conditions.

To adjust the spring preload, turn the adjuster knob.

To reduce (LOW) :

Turn the adjuster counterclockwise toward LOW for a light load and smooth road condition.

To increase (HIGH) :

Turn the adjuster clockwise toward HIGH for a firmer ride and rough road condition.

To adjust to the standard position:

Turn the spring preload adjuster knob counterclockwise until it will no longer turn (lightly seats). This is the full LOW setting. Turn the adjuster clockwise by 7 clicks. At that position, the end of the adjuster knob should be aligned with the indicator line.

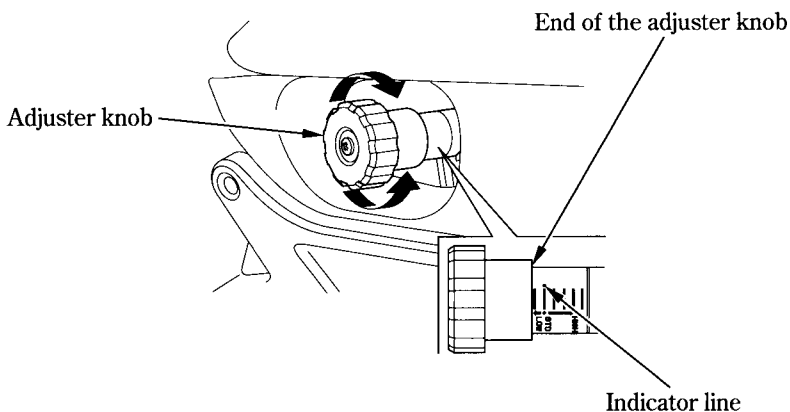

The rear shock absorber assembly includes a damper unit that contains high pressure nitrogen gas. Do not attempt to disassemble or service the damper; it cannot be rebuilt and must be replaced when worn out. Disposal should only be done by your Honda dealer. The instructions found in this owner's manual are limited to adjustment of the shock assembly only.

MAJOR COMPONENTS

(Information you need to operate this motorcycle)

BRAKES

Both the front and rear brakes are the hydraulic disc types.

As the brake pads wear, the brake fluid level drops.

There are no adjustments to perform, but fluid level and pad wear must be inspected periodically. The system must be inspected frequently to ensure there are no fluid leaks. If the control lever or pedal free travel becomes excessive and the brake pads are not worn beyond the recommended limit (page 112), there is probably air in the brake system and it must be bled. See your Honda dealer for this service.

Front Brake Fluid Level:

With the motorcycle in an upright position, check the fluid level. It should be above the LOWER level mark. If the level is at or below the LOWER level mark, check the brake pads for wear (page 112).

Worn pads should be replaced. If the pads are not worn, have your brake system inspected for leaks.

The recommended brake fluid is Honda DOT 4 brake fluid from a sealed container, or an equivalent.

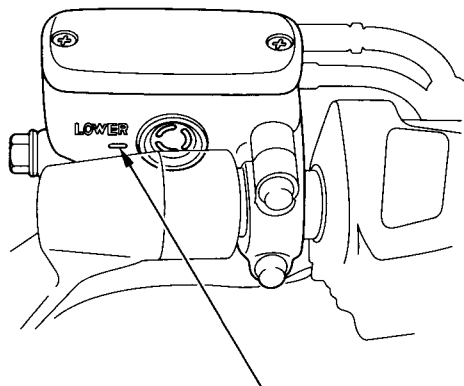

LOWER level mark

The distance between the tip of the brake lever and the grip can be adjusted.

1. Turn the adjuster dial while pushing the brake lever forward.
2. Align the index mark on the brake lever with the numbers on the adjuster dial.
3. Apply the brake, release it, then spin the wheel and check that it rotates freely. Repeat this procedure several times.

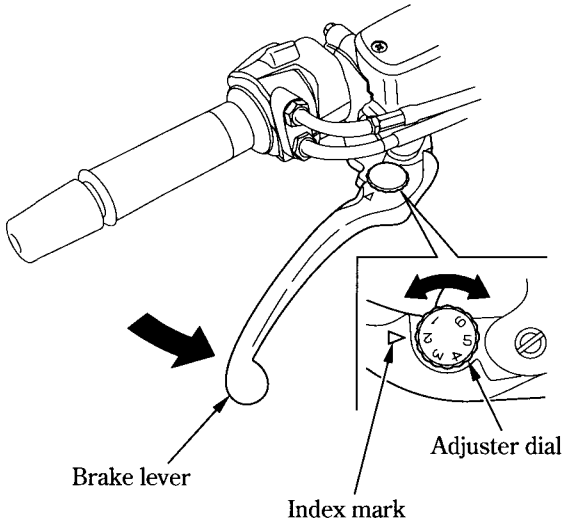

Other Checks:

Make sure there are no fluid leaks. Check for deterioration or cracks in the hoses and fittings.

MAJOR COMPONENTS

(Information you need to operate this motorcycle)

Rear Brake Fluid Level:

The reserve tank is located below the seat.

Remove the front and rear seat and right side cover (pages 55 , 88).

With the motorcycle in an upright position, check the fluid level. It should be between the UPPER and LOWER level marks. If the level is at or below the LOWER level mark, check the brake pads for wear (page 112).

Worn pads should be replaced. If the pads are not worn, have your brake system inspected for leaks.

The recommended brake fluid is Honda DOT 4 brake fluid from a sealed container, or an equivalent.

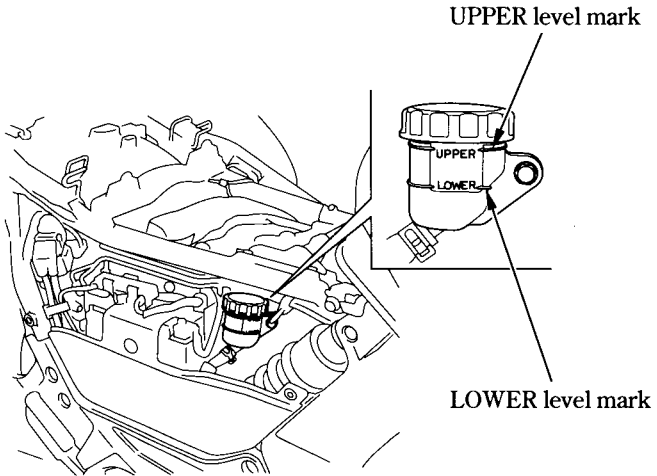

Other Checks:

Make sure there are no fluid leaks. Check for deterioration or cracks in the hoses and fittings.

CLUTCH

This motorcycle has a hydraulically actuated clutch. There are no adjustments to perform, but the clutch system must be inspected periodically for fluid level and leakage.

If the motorcycle creeps or stalls when shifted into gear, or if the clutch slips, causing acceleration to lag behind engine speed, there is probably air in the clutch system and it must be bled out. See your Honda dealer for this service.

Fluid Level:

Check that the fluid level is above the LOWER level mark. If the fluid level is near the LOWER level mark, it indicates fluid leakage. See your Honda dealer for repair.

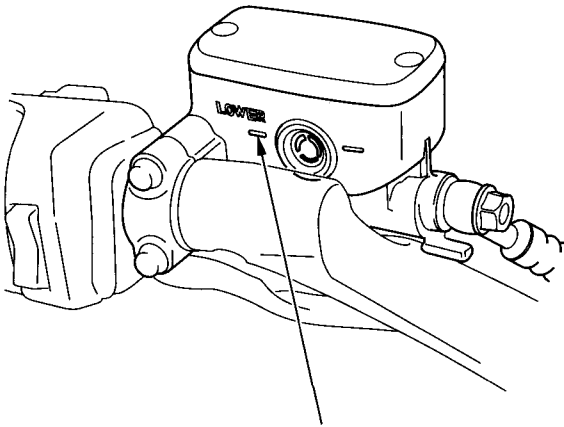

LOWER level mark

Other Checks:

Make sure there are no fluid leaks. Check for deterioration or cracks in the hoses and fittings.

MAJOR COMPONENTS

(Information you need to operate this motorcycle)

COOLANT

Coolant Recommendation

The owner must properly maintain the coolant to prevent freezing, overheating, and corrosion. Use only high quality ethylene glycol antifreeze containing corrosion protection inhibitors specifically recommended for use in aluminum engines. (SEE ANTIFREEZE CONTAINER LABEL).

Use only low-mineral drinking water or distilled water as a part of the antifreeze solution. Water that is high in mineral content or salt may be harmful to the aluminum engine.

Using coolant with silicate inhibitors may cause premature wear of water pump seals or blockage of radiator passages.

Using tap water may cause engine damage.

The factory provides a 50/50 solution of antifreeze and distilled water in this motorcycle. This coolant solution is recommended for most operating temperatures and provides good corrosion protection. A higher concentration of antifreeze decreases the cooling system performance and is recommended only when additional protection against freezing is needed. A concentration of less than 40/60 (40% antifreeze) will not provide proper corrosion protection. During freezing temperatures, check the cooling system frequently and add higher concentrations of antifreeze (up to a maximum of 60% antifreeze) if required.